

basicDIM ILD G2 Programmer

Optional infra-red programming unit for basicDIM ILD G2

Product description

- Optional infra-red programming unit for basicDIM ILD G2
- Setting of predefined parameter values
- Programmable functions such as light level, time delay, P.I.R., bright-out, power up and grouping
- IR range up to 20 m
- Link to manual: <http://www.tridonic.com/qrlLD2Prog>



Standards, page 3





basicDIM ILD G2 Programmer

Optional infra-red programming unit for basicDIM ILD G2

Technical data

Ambient temperature t_a	-10 ... +50 °C
Storage temperature	-20 ... +60 °C
Humidity	10 ... 90 % (non-condensing)
Dimension L x W x H	130 x 56 x 15 mm

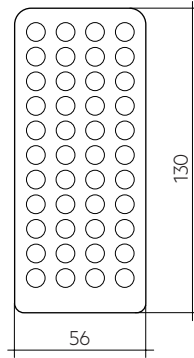







Ordering data



Type	Article number	Packaging, carton	Weight per pc.
basicDIM ILD G2 Programmer	28003484	150 pc(s).	0,04 kg

1. Functions













1.1 Basis functions

Icon	Designation	Description
	ON	Switch luminaires on to max. level. -> Constant light control is deactivated.
	OFF	Switch luminaires off.
	Dim up	Increase current dimming level.
	Dim down	Decrease current dimming level.
	Automatic	Switch luminaire on or change to automatic mode. -> Constant light control enabled: Sensor goes to presence target value. -> Constant light control disabled: Sensor goes to fixed presence level.
	Set current light level	Store the brightness level currently measured by the sensor as target value for constant light control.

















1.2 Push button functions

Icon	Designation	Description
	SET ON	Enable the possibility to set the target value via push button with PBI1 or DALI XC G3.
	SET OFF	Disable the possibility to set the target value via push button with PBI1 or DALI XC G3.









1.3 Constant light control settings

Icon	Designation	Description
	Bright-out ON	Switch on bright-out: If the measured light level exceeds 150 % of the target level for more than 10 minutes, the light is switched off. If the measured light level falls below 100 % of the target level, the light will be switched back on again.
	Bright-out OFF	Switch off bright-out: The light remains switched on at all times, irrespective of the light level measured.
	Convergence ON	Both groups can reach max. level. Group 2 converges to max. level.
	Convergence OFF	Group 2 never reaches max. level. The offset stays at all light levels.
	Constant light control ON	Constant light control is enabled.
	Constant light control OFF	Constant light control is disabled.
	Group offset OFF	Set the difference in brightness between the two groups to 0 %. Group 2 is the same brightness as group 1.
	Group offset -30 %	Group 2 is 30 % less bright than group 1.
	Group offset -50 %	Group 2 is 50 % less bright than group 1.
	Set target value to high (approx. 500 lx)	Set constant light control to a level of approx. 500 lx. Notice: If constant light control is disabled, this button changes the fixed presence level to 100 %.
	Set target value to middle (approx. 300 lx)	Set constant light control to a level of approx. 300 lx. Notice: If constant light control is disabled, this button changes the fixed presence level to 75 %.
	Set target value to low (approx. 150 lx)	Set constant light control to a level of 150 lx. Notice: If constant light control is disabled, this button changes the fixed presence level to 50 %.

1.4 Presence detection profile settings

Icon	Designation	Description
	Presence detection (ON / OFF, run-on time: 20 min)	Enable presence detection. -> Light is switched on and off automatically based on the presence/absence of a person.
	Presence detection (only OFF, run-on time: 20 min)	Presence detection responds only to absence -> Light must be switched on manually (push button, remote control). -> If no person is detected, light is switched off automatically.
	Presence detection (OFF, run-on time: never OFF)	Disable presence detection. Run-on time is automatically set to never off.
	Run-on time 1 min	Set run-on time to 1 minute. -> Time that begins to run from the last moment that presence was detected in the room is set to 1 minute.
	Run-on time 10 min	Set run-on time to 10 minutes. -> Time that begins to run from the last moment that presence was detected in the room is set to 10 minutes.
	Run-on time 20 min	Set run-on time to 20 minutes. -> Time that begins to run from the last moment that presence was detected in the room is set to 20 minutes.
	Switch-off delay 0 min	Set switch-off delay to 0 minutes. -> Light is switched off immediately after run-on time has expired.
	Switch-off delay 1 min	Set switch-off delay to 1 minute. -> Light is switched off 1 minute after run-on time has expired.
	Switch-off delay 30 min	Set switch-off delay to 30 minute. -> Light is switched off 30 minutes after run-on time has expired.
	Switch-off delay never OFF	Set switch-off delay to never off. -> Light is never switched off (keeps the absence level until presence is detected again).
	Absence level 1 %	Set the Absence level to 1 %. -> Dimming level to which the light is dimmed to after the run-on time has expired; applies only if switch-off delay is unequal to 0 minutes.
	Absence level 5 %	Set the absence level to 5 % -> Dimming level to which the light is dimmed to after the run-on time has expired; applies only if switch-off delay is unequal to 0 minutes.
	Absence level 10 %	Set the absence level to 10 %. -> dimming level to which the light is dimmed to after the run-on time has expired; applies only if switch-off delay is unequal to 0 minutes.
	Absence level 30 %	Set the absence level to 30 %. -> Dimming level to which the light is dimmed to after the run-on time has expired; applies only if switch-off delay is unequal to 0 minutes.
	Reserved for future use.	-
	Reserved for future use.	-

1.5 Programming settings

Icon	Designation	Description
	Power up ON	Light is switched on again after a mains break.
	Power up OFF	Light is not switched on again after a mains break until motion is detected.
	Activate test mode	<p>During test mode the system behaves as follows:</p> <ul style="list-style-type: none"> • Run-on time = 15 s • Switch-off delay = 0 s • Bright-out = Disabled • Group offset = -70 % • Constant light control = Disabled <p>Test mode is terminated by one of the following actions:</p> <ul style="list-style-type: none"> • Pressing AUTO button on the ILD G2 Programmer • Power cycling the controller • Waiting for one hour • Another press on test mode button
	RESET	To start the reset process, the button has to be pressed 5 times in 4 seconds.
	Start the grouping	<p>Start the grouping process. All luminaires will blink two times and go to the minimum level. One luminaire will go to the maximum level and can then be added to group 1 or 2 with the respective button.</p> <p>To finish grouping, press this button again or wait for 10 minutes, then it stops automatically.</p>
	Select next luminaire	<p>Select the next luminaire during the grouping process.</p> <p>The selected luminaire will go to the maximum level.</p>
	Add to group 1, remove from group 2	<p>Add the currently selected luminaire to group 1 and remove it from group 2.</p> <p>After that, the next luminaire will be automatically selected.</p>
	Add to group 2, remove from group 1	<p>Add the currently selected luminaire to group 2 and remove it from group 1.</p> <p>After that, the next luminaire will be automatically selected.</p>

2. Installation basicDIM ILD G2 system

2.1 Connection diagrams

Room application:

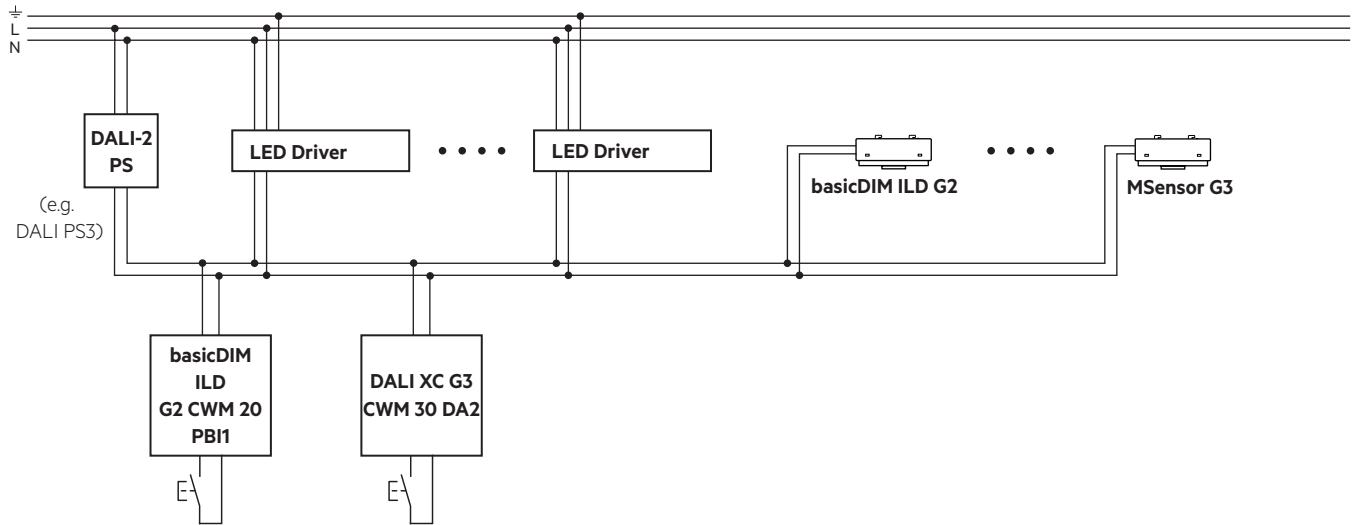

Single / free-standing luminaires, driver with integrated power supply (DALI):

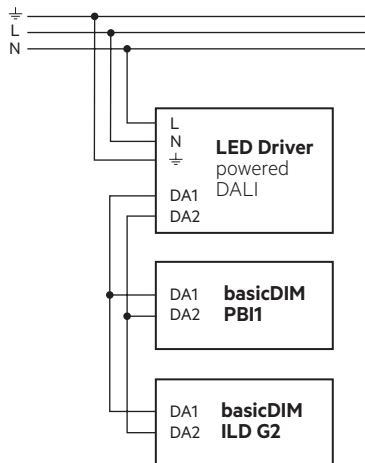

Single / free-standing luminaires, driver with separate power supply (DALI):

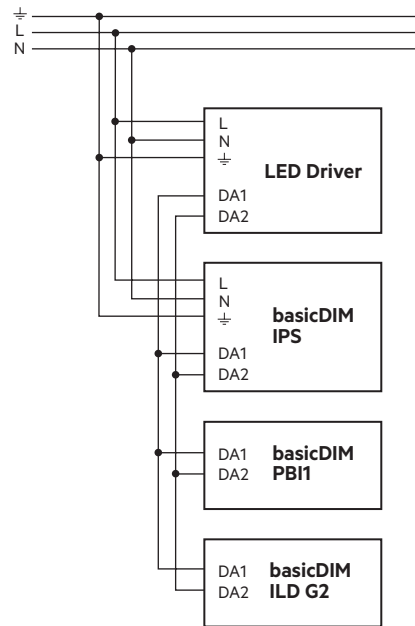

4. Miscellaneous

4.1 Disposal



According to the WEEE directive return old equipment at appropriate collection facilities.

4.2 Additional information

Additional technical information at www.tridonic.com → Technical Data

Guarantee conditions at www.tridonic.com → Services

Lifetime declarations are informative and represent no warranty claim.
No warranty if device was opened.