

SHORT S LENTE

LXT036SL2xxxx1xx

Descripción

Proyector LED para carril trifásico, modelo SHORT S LENTE. Marca Luxlight. Cuerpo fabricado en aluminio. Potencia 28W. CRI90. Óptica 15°/24°/40°. Temperatura 2700K-3000K-3500K-4000K-PW930-PW935. Color blanco.

Aplicación: Iluminación general y de acento para uso interior.

Datos Técnicos

Referencia	LXT036SL2xxxx1xx					
Potencia (W)	28W					
Flujo luminoso	2950lm	3000lm	3100lm	3250lm	2950lm	3000lm
Temperatura color	2.700K	3.000K	3.500K	4.000K	PW 930	PW 935
Eficiencia	104lm/W	108lm/W	113lm/W	117lm/W	104lm/W	108lm/W
Tensión / corriente	220-240V, 50-60Hz / 600mA					
CRI	90					
Ángulo de apertura	15° / 24° / 40°					
Factor de potencia	0,9					
LED	TRIDONIC/PHILIPS					
Temp. trabajo	60 °C					
Vida útil	50.000h					
Lum. Maint. @50K	L80 B10					
Driver	KGP / PHILIPS					
Regulación	CASAMBI / CORTE FASE / DALI					
Protección IP	IP40					
Dimensiones de la luminaria	Ø80mm X 94mm					
Material	Aluminio					
Color	Blanco					
Garantía	5 años					

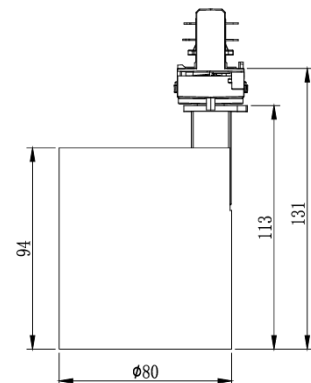
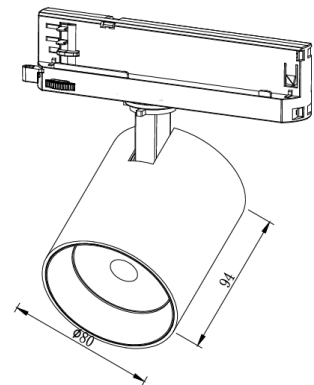

Codificación Completar códigos referencia (x)

Referencia	Temp. (K) (x)	Color (x)	Grados (x)
LXT036SL2xxxx1xx	(35/92/93/94/PW/PW935)	(1)	(15,24,40)

Dimensiones y Peso

Peso neto	460gr
Peso bruto	565gr
Ancho del embalaje	185,0 mm
Profundidad del embalaje	165,0 mm
Altura del embalaje	105,0 mm



SHORT S LENTE

LXT036SL2x1xx

Descripción

Proyector LED para carril trifásico, modelo SHORT S LENTE. Marca Luxlight. Cuerpo fabricado en aluminio. Potencia 26W. CRI90. Óptica 15°/24°/40°. Temperaturas especiales. Color blanco.

Aplicación: Iluminación general y de acento para uso interior.

Datos Técnicos

Referencia	LXT036SL2x1xx						
Potencia (W)	26W						
Flujo luminoso	2900lm	3300lm	3000lm	3100lm	2900lm	2000lm	2000lm
Temperatura color	ART	FISH	FASHION	GOLD	FRUIT	WHITE MEAT	RED MEAT
Eficiencia	111lm/W	126lm/W	115lm/W	119lm/W	111lm/W	76lm/W	76lm/W
Tensión / corriente	220-240V, 50-60Hz / 600mA						
CRI	90						
Ángulo de apertura	15° / 24° / 40°						
Factor de potencia	0,9						
LED	TRIDONIC						
Temp. trabajo	60 °C						
Vida útil	50.000h						
Lum. Maint. @50K	L80 B10						
Driver	KGP / PHILIPS						
Regulación	CASAMBI / CORTE FASE / DALI						
Protección IP	IP40						
Dimensiones de la luminaria	Ø80mm X 94mm						
Material	Aluminio						
Color	Blanco						
Garantía	5 años						

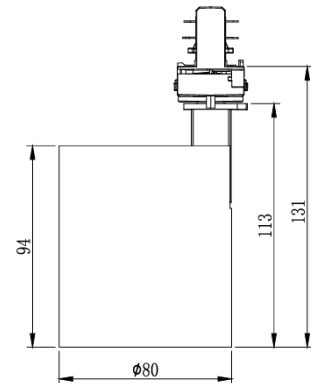
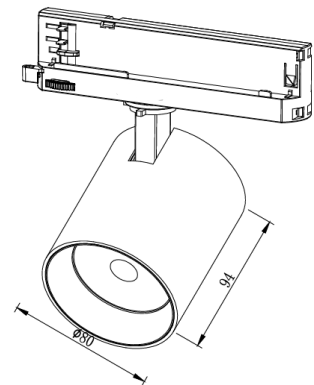

Codificación Completar códigos referencia (x)

Referencia	Temp. (K) (x)	Color (x)	Grados (x)
LXT036SL2x1xx	(ART/FISH/FASHION/GOLD/FRUIT/FRMEAT/REMEAT)	(1)	(15,24,40)

Dimensiones y Peso

Peso neto	460gr
Peso bruto	565gr
Ancho del embalaje	185,0 mm
Profundidad del embalaje	165,0 mm
Altura del embalaje	105,0 mm

